

Understanding Circular Waveguide—Experimentally

Old-fashioned microwave engineering.

By Paul Wade, W1GHZ

Waveguide is an excellent microwave transmission line, with low loss and predictable performance, usable at any frequency by choosing the proper dimensions. The most common type of commercial waveguide is precision rectangular tubing, which is only affordable on the surplus market. Elliptical waveguide is also used commercially for microwave transmission line. Many microwave structures, particularly antennas, have a round cross section and are better suited to circular (cylindrical) waveguide. Unfortunately, commercial circular waveguide is rare and unlikely to

be found surplus. As luck would have it, ordinary copper water pipe works just fine and is universally available at low cost. In particular, $\frac{3}{4}$ -inch copper pipe is perfect for 10 GHz.

Most microwave design today is done with the aid of computers. However, only a few programs handle electromagnetics with the capabilities required for circular waveguide, and their prices are somewhere between a fancy car and a new house. Solving the problems without good software involves some difficult math, and the solution is probably only approximate. The remaining alternative is old-fashioned empirical microwave engineering.

The ham's favorite design technique, reverse engineering (copying something that works!) is made difficult by the lack of commercial circular-

waveguide examples. Reference books have extensive information on rectangular waveguide but very little information on circular waveguide. The pioneering work on waveguides was done by George Southworth before World War II, but I only recently located a copy of his book.¹ I was afraid that I had duplicated some of his work, but that's a good way to learn. On first reading, it appears that he did a lot of work on waveguide fundamentals, but very little on waveguide-to-coax transitions, probably because good coaxial cable and connectors were not available prior to the wartime development.

Circular Waveguide

We all know that electromagnetic

¹Notes appear on page 48.

161 Center Rd
Shirley, MA 01414
w1ghz@arrl.net

waves travel through space—that's what radio is all about. They can also travel inside a hollow pipe of any shape; if the dimensions are right, the pipe makes a very low-loss transmission line, much better than any coaxial cable. In order for the waves to travel with low loss, the pipe dimensions must be large enough for the lowest-order waveguide mode, the TE_{11} mode, to propagate. In circular waveguide, the cutoff wavelength for this mode is $1.706 \times D$ (diameter) so the minimum waveguide diameter is $1/1.706$, or 0.59λ . The diameter of the copper water pipe I used is nominally $3/4$ -inch, type M, which has a larger inner diameter than other types. The typical inner diameter is 0.81 inches, but that may vary slightly because this is not precision tubing. Thus, the cutoff wavelength is 1.38 inches, so the minimum frequency is 8.55 GHz. Clearly, 10 GHz is comfortably above the minimum.

Moving in the other direction, a large waveguide diameter would permit additional higher-order waveguide modes to propagate. While the additional modes also propagate with low loss, they often arrive at the far end with different phase, so that they interfere with the TE_{11} wave and we are unable to extract them without losses. The next mode, TM_{01} , needs a minimum diameter of 0.76λ to propagate, setting the maximum operating frequency without any additional modes. For the $3/4$ -inch pipe, this upper frequency limit is 11.08 GHz, but it isn't a hard limit like the lower cutoff frequency. At higher frequencies, the waveguide still propagates energy, it's just difficult to predictably couple that energy efficiently.

Thus, a hollow round pipe is an excellent waveguide for wavelengths between 0.59 and 0.76 times the inside diameter. Standard USA $3/4$ -inch copper water pipe, type M, has an inner diameter of 0.70λ at 10.368 GHz, so it is ideal for 10-GHz operation. It is readily available in almost any hardware store at a cost much lower than that of coaxial cable suitable for VHF use. Copper water pipe does come in other versions, but type M is preferable since it has the largest inner diameter.

Measurement

Our design style is "old-fashioned empirical microwave engineering." "Empirical" is a fancy word for "cut and try," but it is only engineering if we make measurements, record data and try to understand the results.

The most important measurement we

need is impedance in the waveguide. Today, impedance measurements are made using a network analyzer, preferably one that is automated, with computer control and error corrections. There aren't any waveguide network analyzers; they are all based on coaxial transmission lines. For the most popular standard sizes of rectangular waveguide, good coaxial transitions and calibration kits are available to allow network-analyzer measurements, with the computer correcting errors caused by the transitions. Of course, none of this is available for circular waveguide—if we had a quality coax transition to copy, we'd be one giant step closer to using circular waveguide.

Before network analyzers, microwave impedance measurements were made using a slotted line. A narrow longitudinal slot in the outer conductor of a coaxial line does not interrupt any current flow in the line, so it has no effect. A small probe may be inserted in the slot to measure the voltage in the line, and moved to measure the voltage at other points along the line. If the line is mismatched, the voltage varies in a pattern referred to as a standing wave. Normally, we measure the ratio between the minimum and maximum voltages of the standing wave and call it the standing wave ratio, or SWR. Using a slotted line is becoming a lost art, but the technique is covered pretty well in a recent book by Pozar.²

In waveguide, a slot will have no effect if it does not interrupt any current. In rectangular waveguide, this location is easy to find. It's in the center of the broad wall. In circular waveguide, there is no obvious orientation; we must

orient the guide so that the E-field is symmetrical around the slot and the probe is parallel to the E-field.

I built a slotted line for circular waveguide by cutting a longitudinal slot in a piece of $3/4$ -inch copper pipe. To fit the pipe to a surplus slotted-line carriage, I made a pair of plywood blocks. The carriage is designed for interchangeable line sections of coax or different sizes of rectangular waveguide, so the circular section had to fit the same mounting points for the probe to travel in the slot correctly. Fig 1 is a photograph of the slotted line. Later, I found a sketch³ of Southworth's slotted line. The line section was similar, but without the advantage of a surplus carriage, he had to build a sliding mechanism as well.

To feed RF energy to the slotted line, I started with a surplus coax-to-WR-90 rectangular waveguide section. I then made a rectangular-to-circular transition by hammering one end of a $3/4$ -inch copper pipe until it fit into a WR-90 waveguide flange. This makes a good transition if the shape is a long, smooth taper. I added a WR-90 isolator between the coax transition and the tapered section to absorb any reflected power so that the signal generator would not change frequency or power output due to loading. Finally, at the input to the slotted section of pipe, I added a septum (a flat plate across the diameter of the pipe) perpendicular to the probe; only energy polarized parallel to the probe will propagate past the septum. This polarization is important, so that the E-field is parallel to the probe—otherwise the probe and slot might upset the fields and convert en-

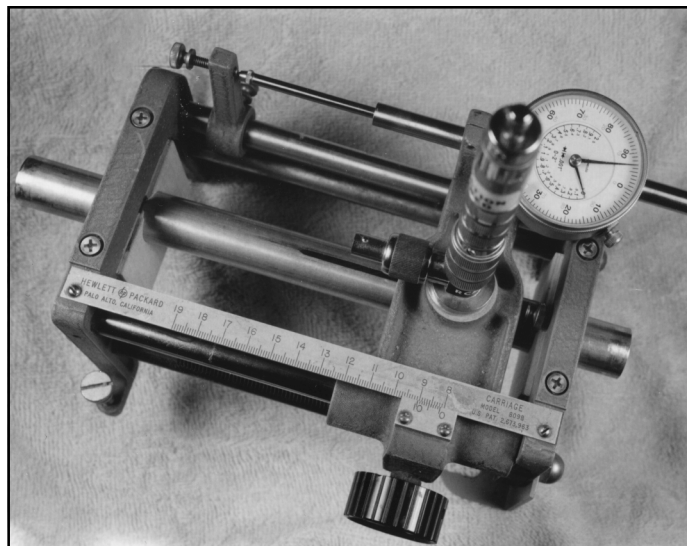

Fig 1—
Homebrew
slotted line for
circular
waveguide
mounted in a
surplus carriage.

ergy to unwanted waveguide modes, with unpredictable results and strange measurements.

The voltage in the slotted line is sampled by the probe inserted through the slot; if the probe is inserted too far, it will affect the fields in the waveguide and produce erroneous readings. On the other hand, a deeper probe produces more output voltage, so less RF power is necessary for the measurement. The proper probe depth is found experimentally, by increasing the depth until the measured SWR starts to change, then backing off.

The probe assembly shown in Fig 1 contains a diode detector with a tuning mechanism; when it is adjusted for resonance, much more detected voltage is available. The output from the detector goes to a standing-wave meter such as an HP415; other manufacturers made similar instruments. The meter is an ac voltmeter tuned to 1 kHz, so the RF source must be AM modulated at 1 kHz; most signal generators have this capability.

Once the slotted line was working, I quickly discovered two things:

1. The wavelength at 10 GHz is nearly twice as long in $3/4$ -inch waveguide as it is in free space.

2. This means that the probe must travel near the end of the slot to measure a full wavelength.

As the probe approached the ends of the slot, I could see that there was an effect. A well-matched horn antenna had a low indicated SWR with the probe near the center of the slot, but a higher indication when it was near the ends. Since commercial rectangular-waveguide slotted sections taper the end of the slot to a point, I used a tapered file to trim the ends of the slot to smooth the response.

Wavelength in the waveguide is measured by shorting the end of the waveguide with a flat plate; this produces a standing-wave pattern with a null every $\lambda/2$ from the short. I knew that guide wavelength, λ_g , would be longer than the wavelength in free space, λ_0 , (phase velocity is greater than the speed of light), but hadn't realized how much longer. Fig 2 shows λ_g versus frequency; as the cutoff frequency is approached, λ_g increases dramatically, while λ_0 increases linearly with decreasing frequency.

Impedance is measured and calculated graphically by plotting SWR and phase on a Smith chart. Phase is measured by the location of the standing-wave minimum voltage on the slotted line. The distance between two stand-

ing-wave minimums is $\lambda_g/2$. With a short circuit on the end of the slotted line, we can locate two voltage nulls on the line to provide the reference points for our measured location. A classic Smith chart has a wavelength scale around the perimeter that is used to plot phase; the circumference of the chart equals $\lambda/2$.

On a Smith chart, the impedance is *normalized* to the characteristic impedance of the transmission line. Common coaxial lines have characteristic impedances near 50 Ω . For waveguide, we use *wave impedance* rather than characteristic impedance. The wave impedance for TE modes in circular waveguide is calculated as:

$$Z_0 = Z_{fs} \left(\frac{\lambda_g}{\lambda_0} \right) \quad (\text{Eq 1})$$

where Z_{fs} is the impedance of free space, 377 Ω . From Fig 2, the guide wavelength, λ_g is longer than the free-space wavelength λ_0 , so our circular waveguide impedance is greater than 377 Ω . Unlike coaxial transmission lines, the impedance varies with frequency. At 10.368 GHz, Z_0 is about 650 Ω ; however, it is about 1130 Ω at 9 GHz and 580 Ω at 11.2 GHz. For our purposes, the exact impedance does not matter, as long as we can match it empirically and achieve a low SWR. In fact, I did not calculate Z_0 until after I had completed all the experimental work described here.

For phase measurements, the slotted line includes a vernier scale to measure distance traveled; the scale is quite accurate if used carefully. However, once I realized that many slotted-line

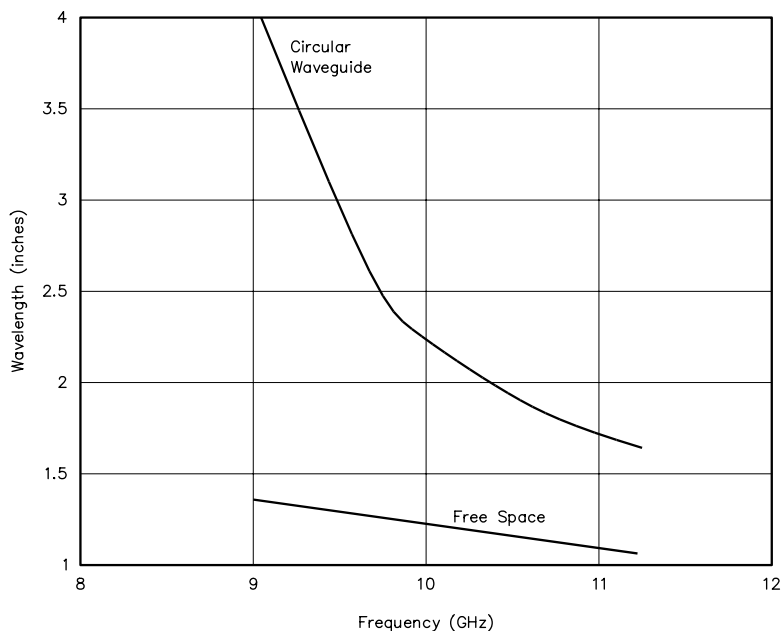

Fig 2—Wavelength does not vary linearly in $3/4$ -inch circular waveguide.

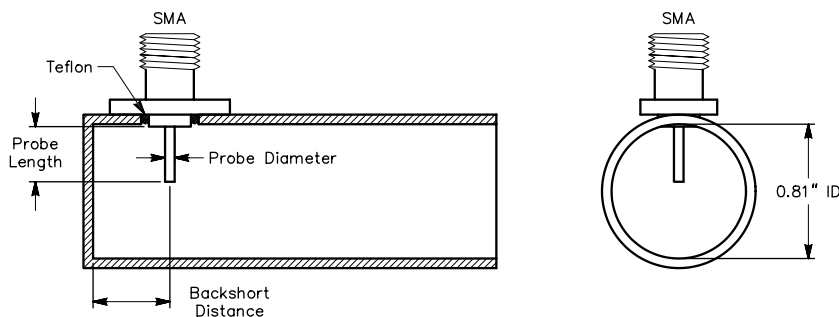

Fig 3—Construction of a $3/4$ -inch pipe waveguide transition.

measurements would be required, I added a dial indicator (shown in Fig 1) to the slotted line. The dial indicator, together with a dial caliper to measure probe dimensions and backshort (I'll explain this term shortly) distances, speeds up measurements significantly. Unfortunately, inexpensive dial calipers and indicators read in inches only, rather than the metric units preferred for microwave work, so we will stick to inches. Anyway, it would be silly to refer to "3/4-inch pipe" in metric units.

Finally, we need a matched load. K2RIW reports carving a tapered point on a broomstick to make a load for circular waveguide, but a horn antenna with a long taper is known to provide a decent match. Therefore, I made a simple conical horn from copper flash- ing. The measured SWR is about 1.14:1.

Coaxial Transition

Our ultimate goal is to make better antennas using circular waveguide, but the antennas must connect to equipment that uses coaxial cable for inter-connections. I had already built several feed antennas for dishes that I wanted to test, but first I needed a good repro- ducible coax transition to connect them. The simplest coax transition extends the center conductor of the coax as a radial probe in the waveguide, as shown in Fig 3. The end of the waveguide behind the probe ends in a short circuit referred to as a *backshort*.

My previous attempts at building transitions from coax to circular waveguide were not always successful. A number of designs have been published for transitions at lower frequencies, but with widely varying dimensions. The ones I have tried were not always well matched, and some were very critical. On closer examination, some of them are feeding mismatched antennas (such as "coffee can" feeds or open circular waveguides with typical SWRs of 2:1), so they are probably adjusted to a spe-

cific mismatch, rather than providing a matched transition.

On the other hand, coax transitions to rectangular waveguide have been more successful, probably because many of them start with dimensions of commercial transitions. I have ad-justed some by making measurements with a rectangular-waveguide slotted line. The measurements suggest that the three variable dimensions in a waveguide transition (shown in Fig 3) all interact. There are combinations of probe diameter, probe length and distance to the backshort that transform the impedance of the waveguide to a desired coax impedance, usually 50 Ω . A textbook I consulted long ago sug- gested that there is an optimum probe length and backshort distance for each desired impedance, but the induc- tance of the probe must be compen- sated by changes in the length and backshort distance. Since the induc- tance is a function of probe diameter, the calculations only provide a rough approximation. Previous experiments at lower frequencies showed that the approximation was not very good.

Since calculations seemed inad- equate, experimentation seemed like a good alternative. I built a fully adjust- able coax transition, shown in Fig 4. A hexagonal plumbing fitting provides flat sides for an SMA panel-mount con- nector, so the probe length and diam- eter can be changed quickly. The con- nector is held by two screws and the Teflon dielectric extends through the pipe wall so that the probe starts at the

inside wall of the waveguide, a repro- ducible position. A sliding backshort provides a full adjustment range. At low frequencies, sliding finger stock is used to provide an adjustable short- circuit, but the fingers are too long to provide a good short at 10 GHz. The al- ternative, shown in Fig 4, is stepped quarter-wave sections: the first section is a sliding fit in the pipe, which provides a very low impedance. It is followed by a small-diameter high- impedance section, then another low- impedance section. The large sections have such low impedances that it doesn't really matter if they make con- tact; the result looks like a short circuit in the waveguide.

My strategy was to make some mea- surements with different probe diam- eters and find a good combination of dimensions for each diameter. I then planned to make some bandwidth measurements to see which combina- tion was least critical, so it could be easily reproduced and scaled to other frequencies.

To choose a range of probe diameters, I looked at published designs. Low-fre- quency designs, for instance 1296 MHz, often use a thin probe of #14 AWG wire. At 10 GHz, this scales to perhaps 0.012 inches, which isn't very substantial. Published designs for higher frequen- cies use probes as large as 0.093 inches, which scales to about a 3/4-inch diam- eter at 1296 MHz. This wide range led me to try a range of diameters, from 0.010 to 0.062 inches, at 10 GHz.

For each probe diameter, I measured

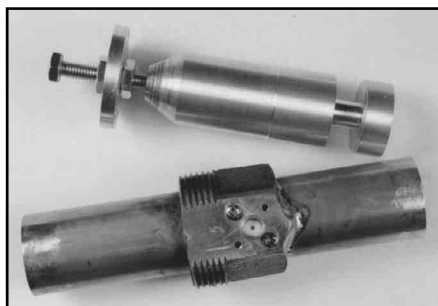

Fig 4—Adjustable circular waveguide-to-coax transition with a sliding short circuit.

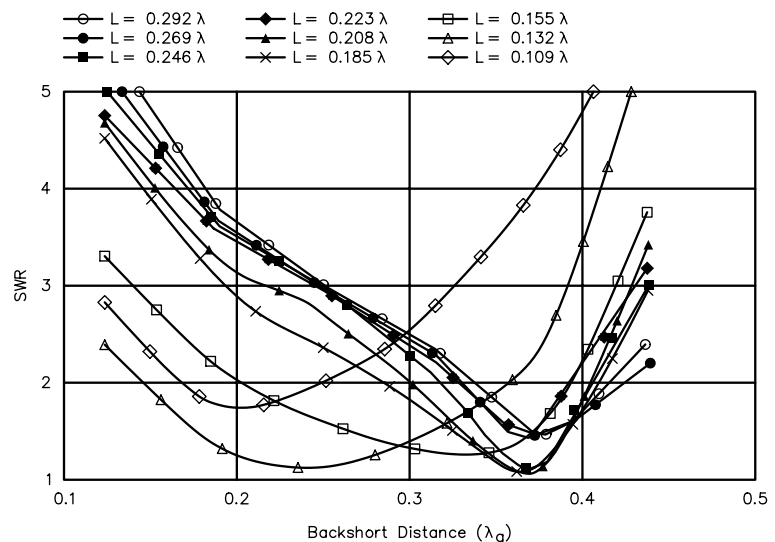

Fig 5—SWR versus backshort distance (in λ_g) for a probe diameter of 0.040 inches.

the waveguide impedance with the SMA connector terminated in a good 50-Ω termination. A low SWR in the waveguide is a good transition. I made the impedance measurement with the backshort distance moving in $\lambda/8$ increments, starting with long probe lengths that I trimmed in small increments.

The plan was simple: plot this data, spot a trend and zero in on optimum combinations. The first plot was SWR only, shown in Fig 5. This is what we would be able to measure with a network analyzer or a directional coupler. Perhaps you can spot a trend in Fig 5, but I only found it confusing!

So much for simple plans, it was time for the Smith chart. In my previous work with rectangular waveguide, plotting a few points by hand was sufficient to understand what was going on. However, I now had dozens of data points and no clear idea of which of them was worth plotting. I downloaded some Smith-chart routines from the Internet, picked a good one and added some code to plot my data in smooth curves on the Smith chart.

The confusing SWR data in Fig 5 is plotted on the Smith chart in Fig 6, with the addition of phase to make each data point a complex impedance. The data shown is for a probe diameter of 0.040 inches. Each solid curve plots a constant probe length with different backshort distances. The points are still well scattered, but one curve, for the shortest probe length of 0.109λ , circles around the center of the Smith chart while the other curves are all on the left side of center. Thus, we might suspect that the optimum probe length may be somewhere between the shortest length and the next longest.

Fig 7 removes the curves for some of the longer probe lengths to concentrate on the ones that bracket the bull's-eye, the center of the chart. The dashed curves intersecting them are plots of constant backshort distance with varying probe length—what you would see if you soldered together a transition and could only trim the probe length. It's clear that neither of these adjustments alone will produce a good transition unless the other is

just right, but one of the dashed lines goes right through the center. The optimum backshort distance should be very close to $0.25 \lambda_g$, or 0.250 guide wavelengths. The points I measured bracket the bull's-eye, so based on those values I tried to estimate a probe length that would land dead center.

Fig 8 is a Smith chart showing the three curves from Fig 7 plus one additional curve, the dashed line, for a probe length that was my estimate of optimum. The best point on this curve has a SWR of 1.05, a decent match. There isn't much point in trying to do better, since neither the slotted line nor the 50-Ω termination on the SMA connector is perfect—each of the measurements has some error and uncertainty.

The horizontal centerline on the Smith chart is the resistive axis; points on the line are purely resistive. Impedances greater than Z_0 , the wave impedance, are to the right of the center point, while lesser impedances are to the left. Points off the centerline have reactive components—inductance is above the centerline, capacitance be-

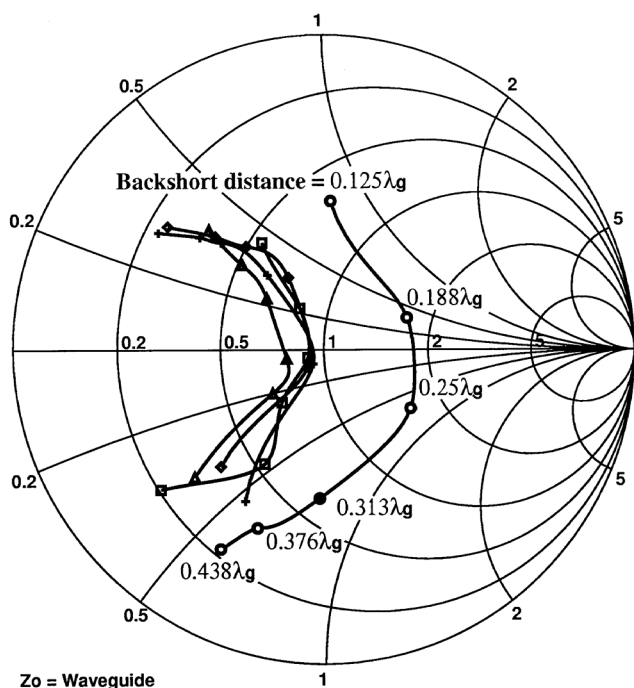

Probe Diameter = 0.040"

- Probe length = 0.215" = $0.109 \lambda_g$
- ▲ Probe length = 0.260" = $0.132 \lambda_g$
- Probe length = 0.305" = $0.155 \lambda_g$
- ◆ Probe length = 0.365" = $0.185 \lambda_g$
- + Probe length = 0.410" = $0.208 \lambda_g$

Fig 6—The SWR data of Fig 5 plotted on a Smith chart.

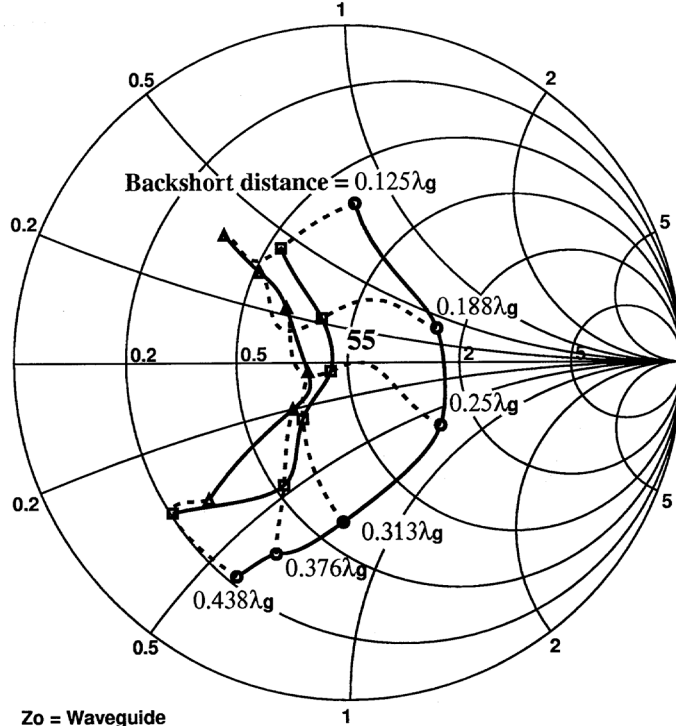

Probe Diameter = 0.040"

- Probe length = 0.215" = $0.109 \lambda_g$
- ▲ Probe length = 0.260" = $0.132 \lambda_g$
- Probe length = 0.305" = $0.155 \lambda_g$

Fig 7—The SWR data of Fig 5 with some of the worst candidates removed.

low. So we can see some trends on these Smith charts: Longer probes produce lower resistances, while longer backshort distances move the reactance from inductive to capacitive. While it is clear from Fig 7 that these aren't straight lines, we can use these trends to "zero in" once we are close.

Returning to Fig 5, we can start to understand the curves. The three shortest lengths are the curves in Fig 7 that bracket the bull's-eye, but the SWR plot doesn't really make this clear. The other curves, for longer probes, all have a sharp minimum somewhere near a backshort distance of $0.375 \lambda_g$; this looks suspiciously like a resonance. Since it is much easier to shorten a probe than to make it longer, I start with an overly long one and trim until it seems to be too short. Therefore, more data is taken with long probes than short ones.

On a Smith chart, we can see combinations of probe length and backshort distance that bracket the desired match at the center of the chart, then estimate the ideal combination from

these data points. I did this for a range of probe diameters from 0.010 to 0.062 inches. Fig 9 is the Smith chart for a probe diameter of 0.050 inches, the diameter of the center pin of an SMA jack. For this diameter, I again found three curves that bracket the bull's-eye, then estimated the best length and measured it for the dashed curve. The lighter dotted lines are plots for constant backshort distance. Fig 10 shows the same set of curves for the largest probe diameter, 0.062 inches, but without the lighter dotted lines.

Turning to smaller probe diameters, Fig 11 shows the curves for a probe diameter of 0.032 inches. In addition to the three that bracket the bull's-eye and the dashed line for my best-estimated length, there is an additional curve for a much shorter probe of 0.107 inches in length. This curve illustrates the trend toward a higher resistive component with shorter probe length—the curve crosses the horizontal axis further to the right.

For a probe diameter of 0.020 inches, I got lucky and cut the probe to

a length that produced a very low SWR, so I stopped there. Fig 12 shows the curves for this diameter, and Fig 13 shows the curves for the smallest diameter, 0.010 inches. At the latter diameter, the best length is significantly longer than with larger diameters, so the second length I tried was already too short and bracketed the bull's-eye. The dashed line is the final curve, for the estimated best length.

For each diameter, there is a good combination of length and backshort distance that provides a well-matched transition from circular waveguide to coax. Our other goal is to find a set of dimensions that is not critical, so that it may be readily reproduced and scaled to other frequencies. If the transition is broadband, with impedance that does not vary rapidly with frequency, it is probably more forgiving than one with rapidly varying impedance. Using the best dimensions for each probe diameter, I made measurements over the frequency range from 9 to 11.2 GHz. This frequency range corresponds to waveguide diameters of 0.617λ to

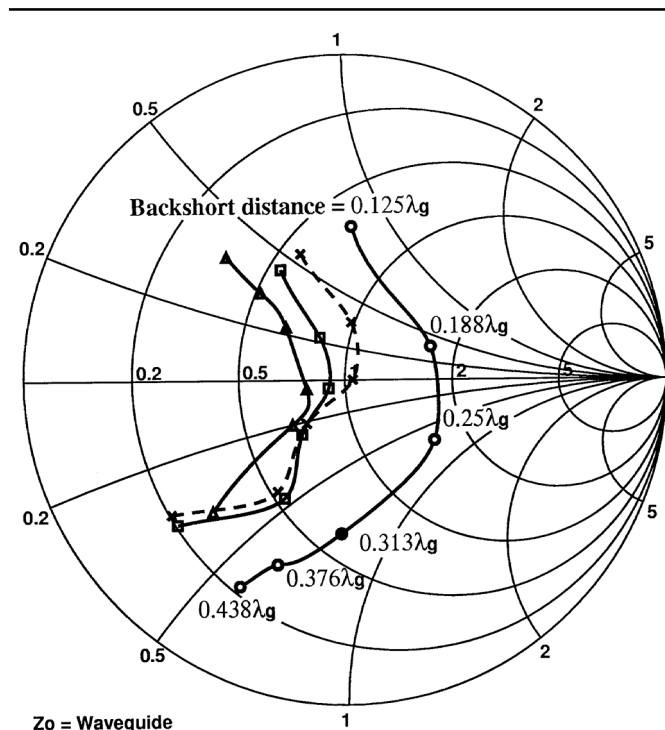

Probe Diameter = 0.040"

- Probe length = 0.215" = $0.109 \lambda_g$
- ▲ Probe length = 0.260" = $0.132 \lambda_g$
- Probe length = 0.305" = $0.155 \lambda_g$
- × Probe length = 0.252" = $0.128 \lambda_g$

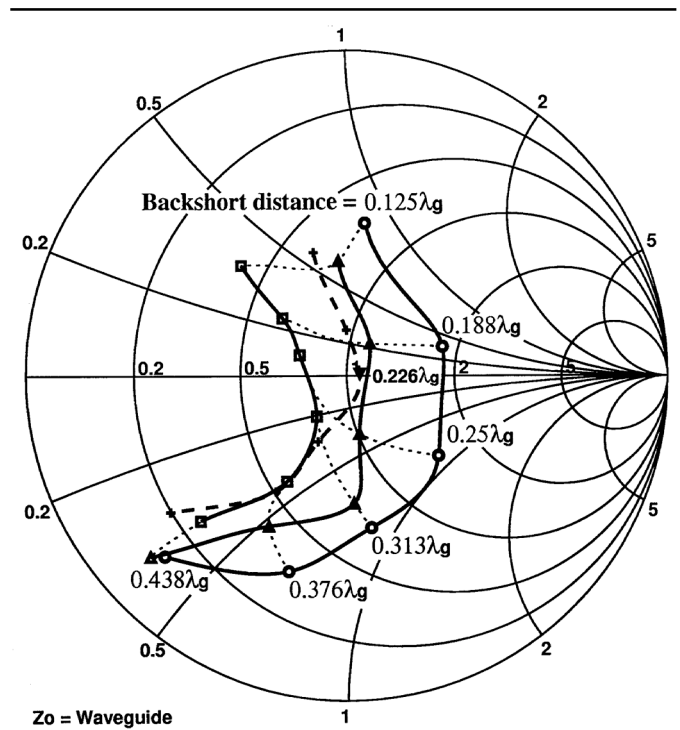

Probe diameter = 0.050"

- Probe length = 0.205" = $0.104 \lambda_g$
- ▲ Probe length = 0.235" = $0.119 \lambda_g$
- Probe length = 0.290" = $0.147 \lambda_g$
- + Probe length = 0.248" = $0.126 \lambda_g$

Fig 8—The SWR curves of Fig 7 with a new dashed line representing the estimated optimum solution.

Fig 9—SWR curves for a 3/4-inch water pipe circular waveguide-to-coax transition. Probe diameter=0.050 inches.

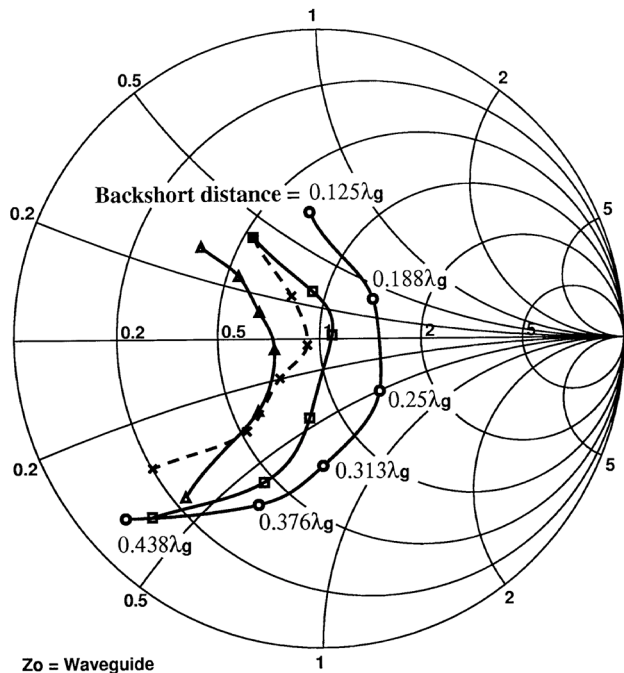

Probe diameter = 0.062"

- Probe length = 0.215" = 0.109 λ_g
- ▲ Probe length = 0.250" = 0.127 λ_g
- Probe length = 0.305" = 0.155 λ_g
- × Probe length = 0.260" = 0.132 λ_g

Fig 10—SWR curves for a 3/4-inch water pipe circular waveguide-to-coax transition. Probe diameter=0.062 inches.

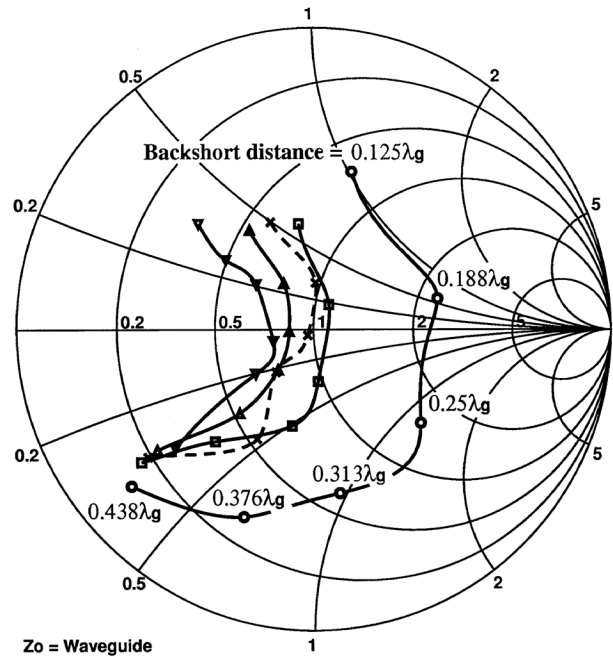

Probe diameter = 0.032"

- Probe length = 0.210" = 0.107 λ_g
- ▲ Probe length = 0.243" = 0.123 λ_g
- Probe length = 0.268" = 0.136 λ_g
- ◆ Probe length = 0.305" = 0.155 λ_g
- × Probe length = 0.252" = 0.128 λ_g

Fig 11—SWR curves for a 3/4-inch water pipe circular waveguide-to-coax transition. Probe diameter=0.032 inches.

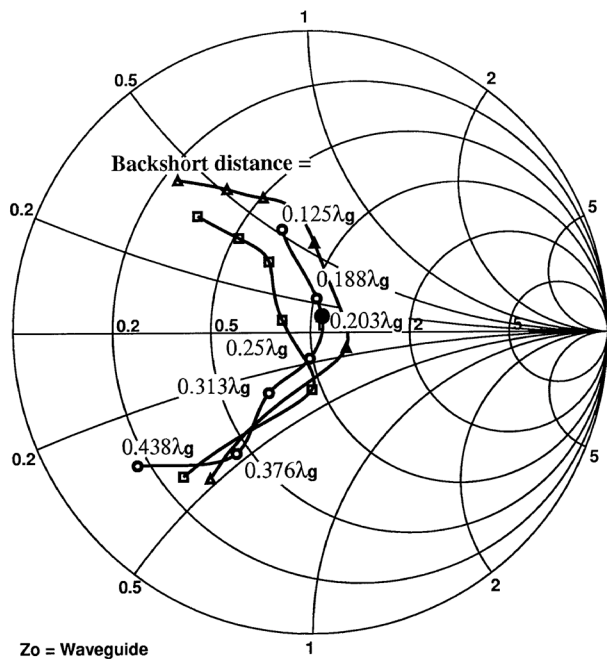

Probe diameter = 0.020"

- Probe length = 0.255" = 0.129 λ_g
- ▲ Probe length = 0.295" = 0.150 λ_g
- Probe length = 0.355" = 0.180 λ_g

Fig 12—SWR curves for a 3/4-inch water pipe circular waveguide-to-coax transition. Probe diameter=0.020 inches.

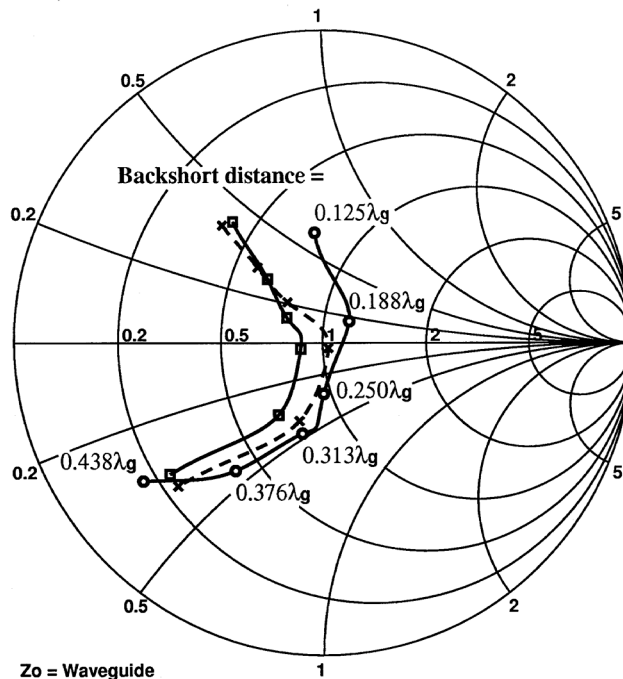

Probe diameter = 0.010"

- Probe length = 0.245" = 0.124 λ_g
- ▲ Probe length = 0.285" = 0.145 λ_g
- × Probe length = 0.265" = 0.135 λ_g

Fig 13—SWR curves for a 3/4-inch water pipe circular waveguide-to-coax transition. Probe diameter=0.010 inches.

0.77λ , the full useful range of circular waveguide.

Impedance is plotted versus frequency in Fig 14 for a probe diameter of 0.020 inches, with the impedance curve forming a tight circle around the bull's-eye over the full frequency range. Notice that these impedances are with respect to the waveguide wave impedance, Z_0 , which changes with frequency; what we are plotting is SWR and phase at each frequency. Even though Z_0 changes by roughly a factor of two across the frequency range, this empirically-designed transition is able to match it to the coaxial 50- Ω characteristic impedance.

Larger probe diameters (in Fig 15) also produce reasonably tight groupings near the center of the Smith chart, indicating a broadband match. Very small probe diameters are less forgiving, with narrower bandwidth as shown in Fig 16, so the #14 wire at 1296 MHz probably also has a narrowband

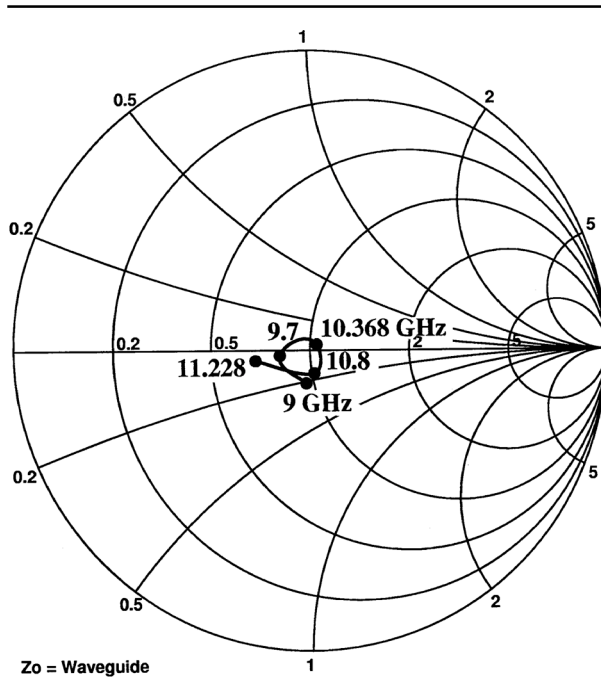

Fig 14—Waveguide impedance variation with frequency for probe diameter=0.020 inches; length=0.255 inches; backshort=0.430 inches.

Smith Chart for Dummies

The Smith chart intimidates many people, including many electrical engineers. For the examples in this article, it isn't necessary to understand the Smith chart—simply think of it as a target, with a bull's-eye in the center where the circle labeled "1" crosses the horizontal (resistive) line. We are trying to hit that bull's-eye, and anything that gets us closer to it is a move in the right direction. Our bull's-eye, in the center of the chart, is the resistive part of the waveguide characteristic impedance (not necessarily 50 Ω) with no reactive component. Any mismatch moves us away from the center of the chart. The shaded bull's-eye in the center of the Smith chart here is the area where SWR is less than 1.5:1, representing a reasonably well matched transmission line.—W1GHZ

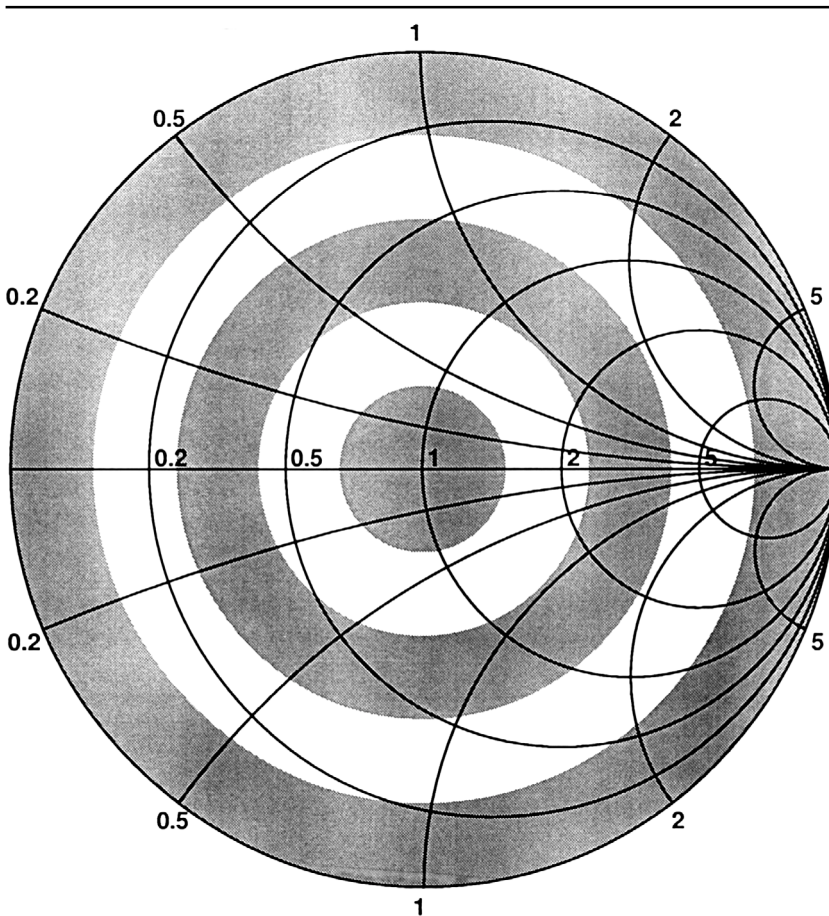

Fig A—For this article, we can imagine a Smith chart as a target.

character. Fig 17 summarizes the best dimensions that I found; the probe length and backshort distance are fairly constant for all probe diameters

except for the smallest diameter, 0.010 inches.

The final question is reproducibility. The most convenient probe diameter

was 0.050 inches, since that is the diameter of common SMA-connector center pins. So fabrication is simply a matter of cutting and filing the pin to

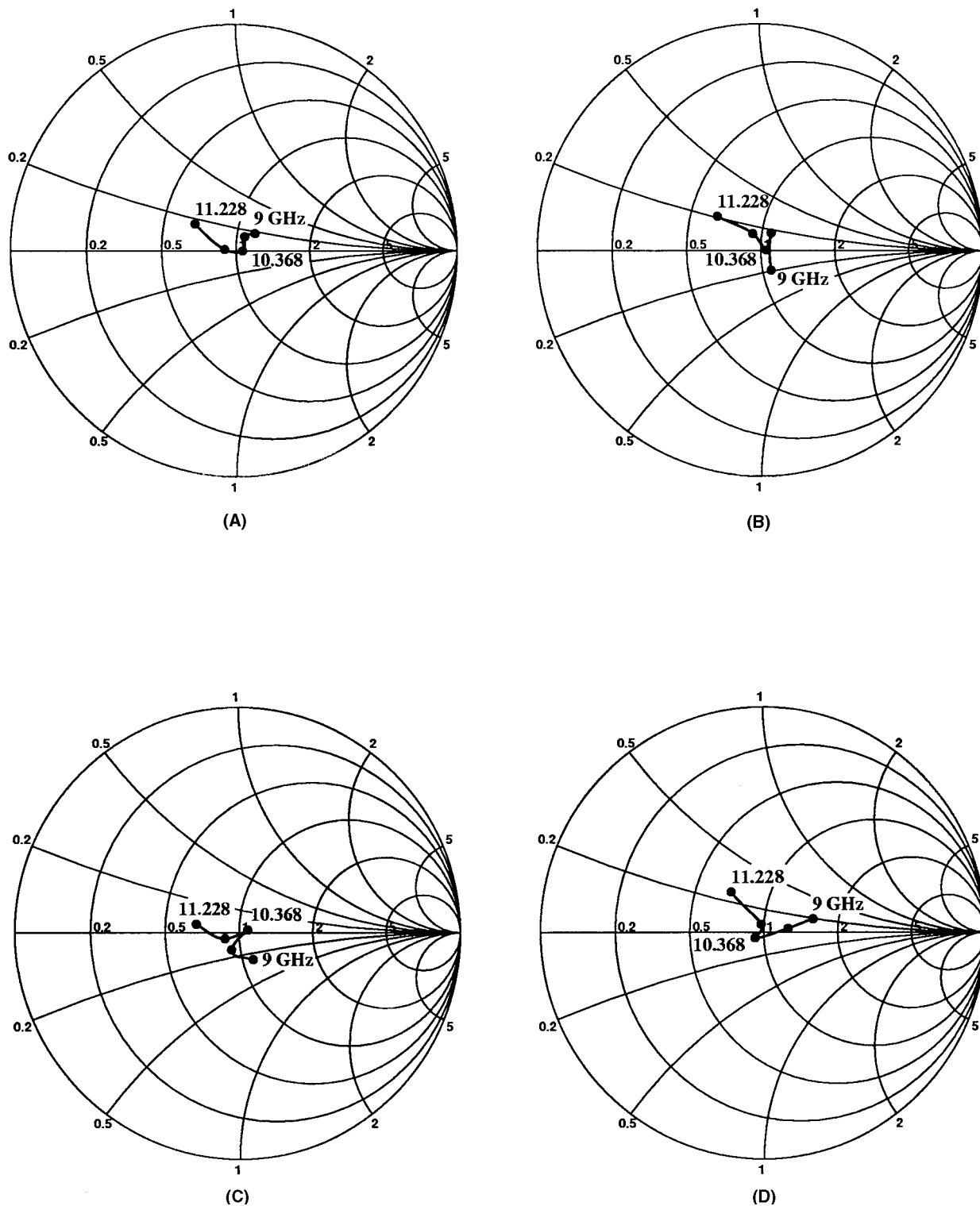

Fig 15—SWR curves for larger probe diameters. (A) Probe diameter=0.032 inches; length=0.252 inches; backshort=0.485 inches. (B) Probe diameter=0.040 inches; length=0.252 inches; backshort=0.493 inches. (C) Probe diameter=0.050 inches; length=0.248 inches; backshort=0.440 inches. (D) Probe diameter=0.062 inches; length=0.260 inches; backshort=0.500 inches.

the desired length read from Fig 17. I cut up another hexagonal plumbing fitting to provide several flats for connector mounting, then soldered one to the side of a piece of pipe as well as a small brass sheet for a backshort. I drilled and tapped holes in the flat for the connector and screwed it in place. The transition worked well, providing an SWR of about 1.05 feeding a diagonal horn, so I assembled three more, using flats from the hexagonal fitting. An alternative construction technique is to use an SMA connector with a threaded body, which allows for some adjustment. Screwing the connector flange to a flat surface is more robust and repeatable, however, and adjustment isn't necessary if we have good dimensions.

I made the final measurements of the four transitions from the coax input using an automatic network analyzer. Fig 19 shows the SWR of all four transitions, each feeding a diagonal horn⁴ with SWR of about 1.06. The worst transition has an SWR of about 1.11 at 10.368 GHz, while the others are 1.05 or lower. The SWR is under 1.5 from 9.8 to 11+ GHz, a reasonable bandwidth. To measure the loss, I connected two transitions together with a simple plumbing joint slipped over them. The loss for a pair, shown in Fig 20, is 0.23 dB at 10.368 GHz and under 0.3 dB from 9 to 11 GHz. At 8.5 GHz, the cutoff frequency is obvious; waveguide makes an excellent high-pass filter.

Scaling to Other Frequencies

I believe the transition should scale well to other frequencies. The hardest part is finding a pipe of suitable diameter, between 0.6λ and 0.76λ . Then the other dimensions can be scaled directly to the ratio of pipe diameters, starting with a convenient probe diameter and taking the dimensions from Fig 17. All dimensions must be scaled by the same ratio! If the probe length is made slightly long, it can be trimmed for best SWR.

Antenna Applications

The real purpose of the circular waveguide was to investigate antennas with circular cross sections, particularly feed horns. I built several feed horns for offset dishes, including the ones shown in Fig 21: a conical horn, two large W2IMU dual-mode feed horns and a rectangular horn feed for DSS offset dishes. I also built a diagonal horn,⁵ a feed horn with a square cross section rotated so that the probe is parallel with the diagonal. I made SWR and sun-noise measurements on these

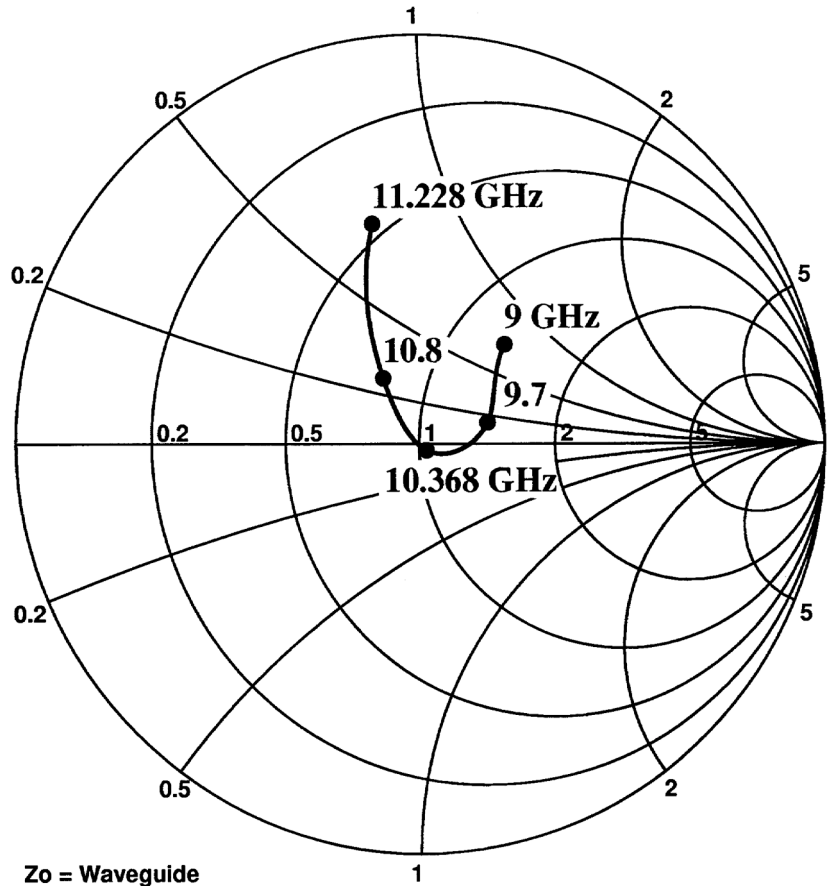

Fig 16—SWR curves for a very small probe diameter. Probe diameter=0.010 inches; length=0.265 inches; backshort=0.616 inches.

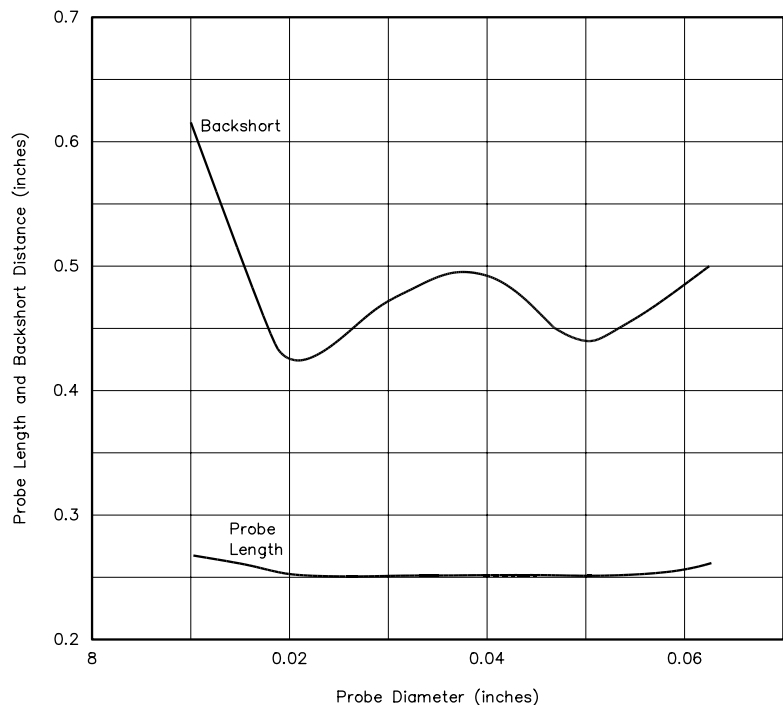

Fig 17—Circular waveguide-to-coax transition—best dimensions.

horns as well as several surplus corrugated horns with circular-waveguide inputs, which I machined to fit to $3/4$ -inch pipe. All the homemade horns had SWRs better than 1.1. The diagonal horn had particularly good SWR but disappointing feed performance.

The two W2IMU dual-mode feed horns are large versions, optimized for offset dishes as described in the W1GHZ Microwave Antenna Book—Online.⁶ The original W2IMU feed⁷ provides best performance for an f/D around 0.5. The two dual-mode horns in Figure 21 are designed for larger f/D required for offset dishes: the larger version in Figure 21 is dimensioned for $f/D = 0.8$ and the smaller for $f/D = 0.7$. For a dual-mode horn to properly illuminate a larger f/D , not only must the aperture diameter increase, but also the length of the output section must increase and the flare half-angle must decrease. The dashed lines in Figure 22 illustrate these changes from the original version depicted by the solid lines. The two large dual-mode feed horns provided the highest efficiency I've measured to date, slightly higher than the rectangular feedhorn⁸ I designed for offset dishes. One interesting result was that the efficiency was slightly higher with circular polarization than with horizontal polarization. The middle horn in the table is currently working well feeding a one-meter offset dish as part of my 10-GHz periscope^{9, 10} antenna system.

The dimensions for these two larger dual-mode feeds as well as the original W2IMU feed are shown in the following Table 1. The dimensions are shown in wavelengths and may be scaled to any frequency. Dimension A is not shown in the table; it is the diameter of the input circular waveguide feeding the horn. The diameter of the input waveguide does not affect horn performance as long as only the TE₁₁ mode is propagated. As we saw previously, a range of waveguide diameters is usable.

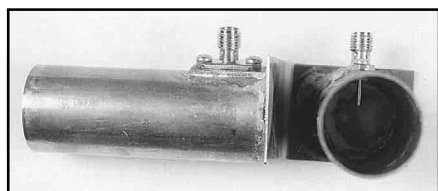

Fig 18—A completed circular waveguide-to-coax transitions for 10 GHz.

Table 1—Dimensions two dual-mode feeds and the original W2IMU feed

Dimensions shown in wavelengths may be scaled to any frequency.

f/D	Flare	$B=$ Aperture Diam.	$C=$ Output Length
0.55	30	1.31λ	1.31λ
0.7	27.4	1.63λ	2.8λ
0.8	24.9	1.79λ	3.52λ

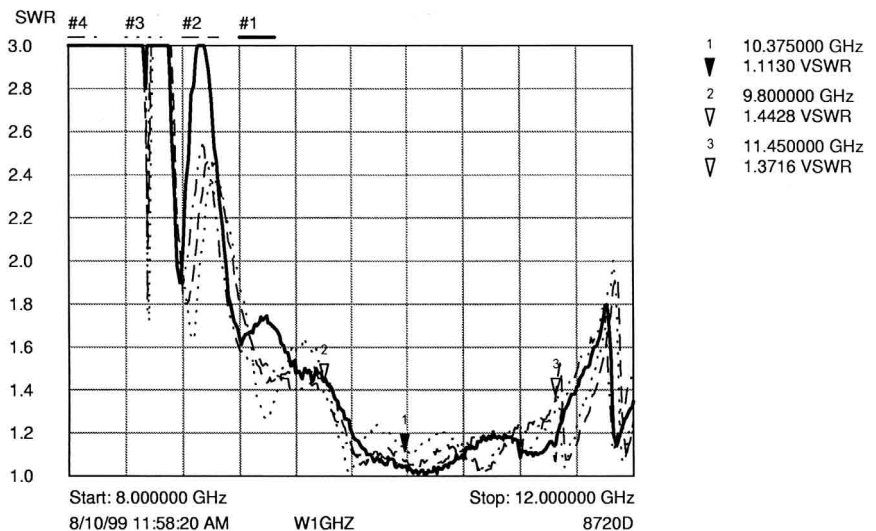

Fig 19—Measured SWR for the completed $3/4$ -inch circular waveguide transitions with a diagonal-horn load.

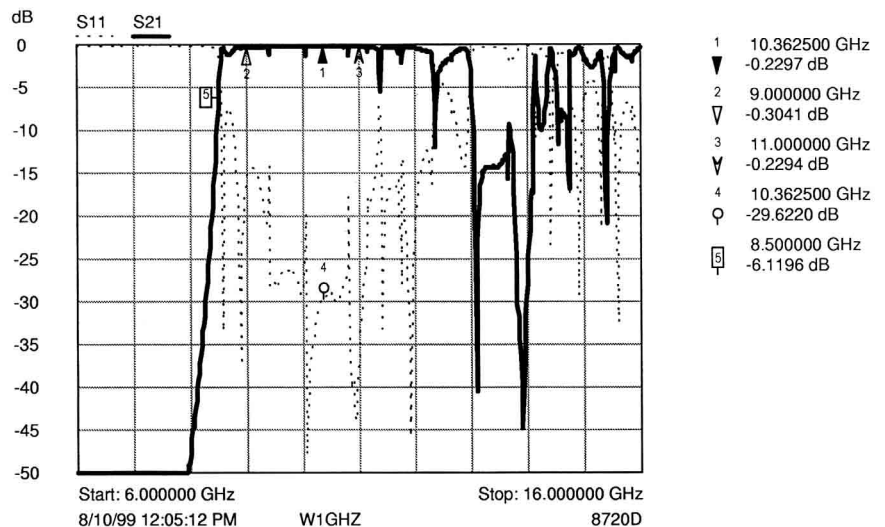

Fig 20—Losses for a mated pair of $3/4$ -inch circular waveguide transitions.



Fig 21—10-GHz feed horns for DSS offset dishes.

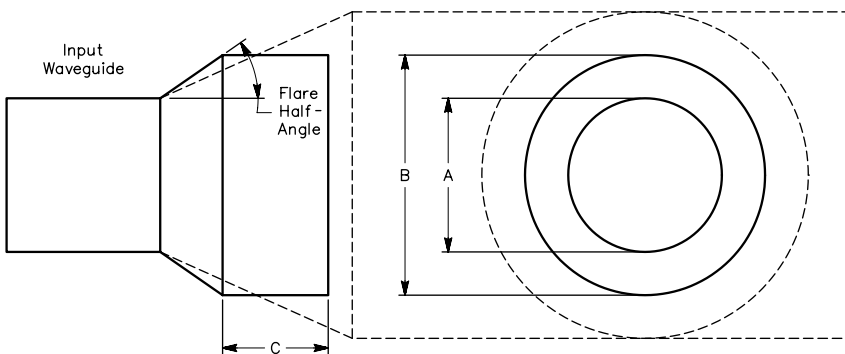

Fig 22—The W2IMU dual-mode feed horn. See Table 1 for dimensions.

Conclusions

Circular waveguide for 10 GHz use made from ordinary copper pipe is both useful and inexpensive. Using simple test equipment and old-fashioned experimental microwave engineering, I have found some good working dimensions for quality circular-waveguide components. In the process, I learned more about circular waveguide. I hope this demonstrates that fancy test equipment is not always necessary for microwave work.

Notes

- ¹G. C. Southworth, *Principles and Applications of Waveguide Transmission*, (Princeton, NJ: Van Nostrand, 1950).
- ²D. M. Pozar, *Microwave Engineering*, second edition, (New York: Wiley, 1998) pp 79-82.
- ³G. C. Southworth and A. P. King, "Metal Horns as Directive Receivers of Ultra-Short Waves," *Proceedings of the IRE*, February 1939, pp 95-102. (reprinted in A. W. Love, *Electromagnetic Horn Antennas*, IEEE, 1976, pp 19-26.)
- ⁴R. Chatterjee, *Elements of Microwave Engineering*, (Ellis Horwood Limited, 1986; New York: Halsted Press, 1986) pp 168-169.
- ⁵A. W. Love, "The Diagonal Horn Antenna," *Microwave Journal*, March 1962, pp 117-122 (reprinted in A. W. Love, *Electromagnetic Horn Antennas*, IEEE, 1976, pp 189-194.)
- ⁶You can view this at www.qsl.net/n1bwt/preface.htm; go to Chapter 6.5.

- ⁷R. H. Turrin, W21MU, "Dual Mode Small-Aperture Antennas," *IEEE Transactions on Antennas and Propagation*, AP-15, March 1967, pp 307-308. (reprinted in A. W. Love, *Electromagnetic Horn Antennas*, IEEE, 1976, pp 214-215.)
- ⁸P. C. Wade, N1BWT, "More on Parabolic Dish Antennas," *QEX*, Dec 1995, pp 14-22.

- ⁹P. Wade, W1GHZ, "10 GHz without Feed-Line Loss," *Proceedings of the 24th Eastern VHF/UHF Conference*, (Newington, Connecticut: ARRL, 1998), pp 227-237.
- ¹⁰P. Wade, W1GHZ, "Periscope Antenna Systems," *Proceedings of Microwave Update 2000*, Treveose, Pennsylvania, 2000, pp 182-202. □□

 <p>SALE</p>	<h2 style="text-align: center;">ATOMIC TIME™</h2> <p style="text-align: center;">...self setting ...correct time ...atomic clock</p>	
<p>Atomic Watch hard mineral lens, hi-tech polymer case black leather band \$109.95</p>	<p>World's most exact time... atomic clocks, atomic watches and weather stations</p>	<p>atomic dual alarm clock w. temperature day and date, black 3.5x4.5x2 \$29.95</p>
	<p>¥ for any time zone ¥ synchronized to the u.s. atomic clock in colorado ¥ accurate to 1sec. in 1 mil. years ¥ engineered in germany</p>	
<p>atomic radio with 2 alarms and temperature, day, date, LCD \$39.95</p>	<p>complete line of atomic clocks JUNGHANS MEGA CERAMIC Watch JUNGHANS MEGA CARBON Watch JUNGHANS MEGA CLOCKS JUNGHANS SOLAR WATCHES ATOMIC SPORTS WATCHES ATOMIC SCHOOL/OFFICE CLOCKS ATOMIC INDUSTRIAL CLOCKS Oregon Scientific Weather Stations, Weather Forecast, World Time, NOAA Radios, Radio Controlled Clocks...</p>	<p>jumbo digit atomic clock w. temperature & day and date, wall or desk 8.5 x 8.5 x 1 ¥ \$49.95</p>
 <p>NEW</p>	<p>call for our FREE Brochure or go to www.atomictime.com credit card orders call toll free 1-800-985-8463 30 Day Money Back Guarantee send checks incl. s&h \$6.95 to</p>	
<p>Junghans atomic carbon, stainless bezel, sapphire lens LCD day, date - carbon/leather band ¥ \$279.00</p>	<p>ATOMIC TIME, INC. 1010 JORIE BLVD. OAK BROOK, IL 60523</p>	<p>black arabic 12 wall clock for home or office ¥ \$59.95 (wood \$69.95)</p>